



Healthy, comfortable
and energy-efficient ventilation

Air for Life



Flair 225, 325 & 400

New generation ventilation with HRV

Rated as the best
HRV appliance

Central ventilation

The Flair is a balanced heat recovery ventilation appliance (HRV). The Flair 225, 325 & 400 have a ventilation capacity of 225, 325 and 400 m³/h respectively. The appliance is available as a left-handed and right-handed version with four top connections (4/0). The Flair 325 and 400 also come with two top and two bottom connections (2/2) as well as a version with enthalpy exchanger. There is an optional Plus print for even more connection options. In addition, the appliances come as standard with fully automatic 100% bypass and intelligent frost protection.

Excellent performance

Its aerodynamic design makes the Flair more effective, quieter and considerably more energy-efficient than similar products. The unique constant flow fans, combined with the integrated control system, ensure a perfect balance between incoming and outgoing air.

Modern communication

The Flair can be connected to other appliances and systems in various ways:

- Modbus. Ensures an easy link with building management systems (standard).
- Brink Home. The appliance can be operated and controlled online through the app or a web portal using a telephone, tablet or computer (using the optional Plus pcb).

Installation and service convenience

The Flair range is designed identically. That saves time at both installation and maintenance. The variation in service parts is minimal.

Complete range of accessories

A complete range of accessories is available such as a postheater, a mounting support, mufflers, air distribution systems and control options. Various control options are available. Opt for manual or fully automatic control based on CO₂, time or relative humidity, for the entire home or per zone.

Make living even more comfortable and healthier by combining the Flair with:

- Humidifying. Improve the moisture balance in the house with the Evap or the enthalpy exchanger.
- Cleaning. Filter the incoming outdoor air with fine dust filters, carbon filters and/or the Pure induct.
- HRV without supply ducts. The Multi Air Supply system is a particularly outstanding solution for existing buildings.

The advantages at a glance

For healthy and comfortable living and working conditions

Optimum balance between thermal efficiency and energy use

NZEB-ready

Very quiet operation

Compact size

Ecodesign energy label A or A+ (with demand control)

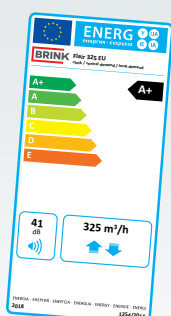

Green energy labels according to Ecodesign



BRINK

Air for Life



Renovent Excellent 180, 300, 400 and 450

Silent and low-energy ventilation

Central ventilation

The Renovent Excellent is an appliance for balanced heat recovery ventilation (HRV) and it comes in several versions with ventilation capacities of 180, 300, 400 and 450 m³/h. The Plus version of these appliances has a 0-10 V input and connection options for a CO₂ sensor and a postheater.

Silent

The Renovent Excellent is renowned for its low sound level. This is the result of the use of a metal housing, slow-running fans and low internal resistance.

Flexible assembly

The Renovent Excellent is available in a left-handed and right-handed version. The Renovent Excellent 180 and 450 have four top connections (4/0). With its compact design, the Renovent Excellent 180 can even be installed in a kitchen unit.

The Renovent Excellent 300 and 400 are available in three versions:

1. Four top connections (4/0)
2. Three top connections and one bottom connection (3/1)
3. Two top connections and two bottom connections (2/2)

The latter version allows the ducts from and to the dwelling to be fed into the ground directly beneath the appliance, after they have been fitted with acoustic muffling. That way no ducts are required next to the appliance. The Renovent Excellent appliances are suitable for installation on the wall. A mounting support is available for the Renovent Excellent 300, 400 and 450 as well.

Enthalpy exchanger

In wintry conditions, the enthalpy changer ensures that part of the moisture in the exhaust air is transferred to the supplied dry outside air. This prevents excessive dehydration of the indoor air. The enthalpy exchanger is available for the appliances Renovent Excellent 300, 400 and 450.

Complete range of accessories

A complete accessories programme is available for the Renovent Excellent, including Air Control, control switches, wireless RF, 2-zone demand flow, Brink Home, air quality sensors (CO₂ and RH), Brink Connect (Modbus), Pure induct, Evap, mounting support, enthalpy exchanger, mufflers and several air distribution systems.

Complete, silent and low-energy

The advantages at a glance

For healthy and comfortable living and working conditions

High-efficiency heat recovery tested under EN13141-7

Highest efficiency under all conditions through application of Constant Flow control

Standard 100% bypass

Bypass functionality for Renovent Excellent 180

EC fans guarantee a low auxiliary energy consumption

Ecodesign energy label A or A+ (demand control) for Renovent Excellent 300 and 400

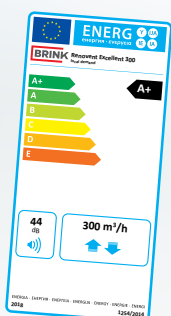

Green energy labels according to Ecodesign



BRINK

Air for Life



Renavent Sky 150, 200 and 300

Compact and space-saving

Central ventilation

The Renavent Sky is an appliance for balanced heat recovery ventilation (HRV) and it is available in ventilation capacities of 150, 200 and 300 m³/h. In addition to the complete standard version, a Plus version of these appliances is available. It has additional connection options for CO₂ sensors and a postheater. The Plus version is also fitted with a potential-free input and a 0-10 V input. The Renavent Sky 150 and 200 are unique for their very modest height of no more than 198 mm. That makes them highly suitable for renovation of compact dwellings such as student flats or senior citizens dwellings. The Renavent Sky 300 is highly suitable for central ventilation of larger homes, apartments and offices where this appliance is the best solution because of the available space.

Silent

Its design with, for instance, metal housing, slowly running fans and low internal resistance, makes the sound level of the Renavent Sky very low. In addition to the usual flexible muffler, various special muffler modules are available for the Renavent Sky 150 and 200. These modules are geared for the compact design and can be attached directly to the appliance.

Enthalpy exchanger

In wintry conditions, the enthalpy exchanger ensures that part of the moisture in the exhaust air is transferred to the supplied dry outside air. This prevents excessive dehydration of the indoor air. The enthalpy exchanger is available for the Renavent Sky 300.

Extension options

For the Renavent Sky, a complete range of accessories is available such as the Air Control, multiple switch, wireless RF, 2-zone demand control, Brink Home, air quality sensors (CO₂ and RH), Brink Connect (Modbus), filters, the Pure induct, the Evap, mufflers and various air distribution systems.

Flexible assembly: wall and ceiling

The advantages at a glance

For healthy and comfortable living and working conditions

High efficiency heat recovery tested under EN13141-7

Constant Flow Control

100% bypass

Low auxiliary energy consumption through application of EC fans

Ecodesign energy label A Label A+ (demand control Renavent Sky 300 and 150)

Manifolds with acoustic insulation

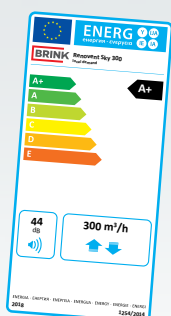

Green energy labels according to Ecodesign



Muffler modules



BRINK

Air for Life



Air 70

HRV without air ducts

Decentral ventilation

The Air 70 is a compact, decentral, balanced heat recovery ventilation appliance (HRV) and it is available with a ventilation capacity of 70 m³/h. The appliance can completely be installed in an exterior wall. The wall sleeve diameter is Ø 250 mm. The ventilation air is supplied and exhausted straight through the exterior wall. No ducts system required. The Air 70 is excellently suitable for use in renovation, conversions or compact new dwellings.

The Air 70 comes as standard with a 100% bypass and a built-in preheater for frost protection. As standard, the appliance is controlled with two touch buttons. The five LEDs display the various modes and messages. The Air 70 Plus version offers additional connection options for a CO₂ sensor, humidity sensor, wireless control RF, RJ for the multiple switch, Brink Home, eBus and Brink Connect (Modbus).

Silent and low-energy

With its advanced technology, the Air 70 is a very silent decentral ventilation appliance. On top of that, the appliance is very energy-efficient. The fresh supply air is guided through the built-in round heat exchanger where it is preheated by the stale and warm air that is exhausted from the space. That results in adequate ventilation with hardly any heat losses.

Design

The compact appliance hood on the inside of the wall is of a slim, unobtrusive design. The occupant may paint the Air 70 in any desired colour in accordance with the instructions. That makes the Air 70 blend in with in any interior. There is a choice of grilles in various colours for the outside wall face.

The advantages at a glance

For healthy and comfortable living and working conditions

Counter-flow exchanger

Very low noise load

Approved under European regulations EN13141-8

100% bypass

Highly energy-efficient

Easy to install

Can be completely be installed in the exterior wall

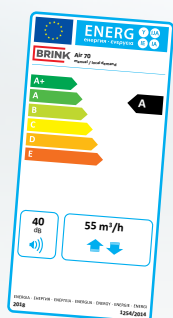

Green energy labels according to Ecodesign

BRINK

Air for Life

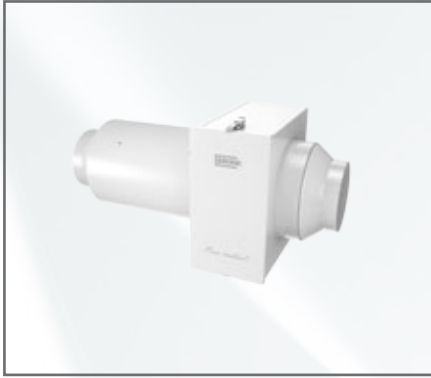

Pure induct

For the most
healthy ventilation air

Air purification

The Pure induct captures the particles present in the air. These particles include harmful dust, fine and ultrafine particles, viruses, bacteria, pollen and fungi. By capturing those, the air is purified of pollutants and thus cleaner and healthier. Especially in areas where air pollution is a problem and fine dust is released, the Pure induct is the ultimate solution when you want to keep ventilating healthily. The Pure induct is mounted in the duct that transports outdoor air from the ventilation appliance to the living spaces.

Operation

The Pure induct uses ionisation to ensure that dust particles are captured from the air. An ionisation system charges the airborne particles. At the end of the module, the statically charged filter catches the particles. That way all pollutants are removed from the air and pure, healthy air enters the home. Note: only a genuine Brink filter guarantees a high effectiveness.

Effective filter

The special filter of the Pure induct has a lower resistance than the heavier HEPA filter, while its static features combined with particles ionisation makes it just as effective. The filter will block less easily so it remains effective for a longer period. In addition, the lower resistance has the advantage that the fan can run at a lower rpm, thus reducing the energy consumption and the sound emission.

The Pure induct is effective against:

- Coarse dust
- Fine dust (PM10-PM2.5)
- Ultra fine dust and nanoparticles (PM1)
- Microbiologic pollutants such as: viruses, bacteria, fungi, spores and pollen

Clean air in your home,
air pollution stays outside

The advantages at a glance

For healthy and comfortable living and working conditions

A clean and healthy indoor climate

Fully automatic operation

Low air resistance leads to low energy consumption

Perfectly safe

More effective than HEPA filters

BRINK

Air for Life



Evap

Optimises the moisture balance of the indoor air

Air humidification

The Evap is a system module that restores the moisture balance in the home. In wintry conditions, outside air can contain little moisture and cause the air in the house to become very dry. Too dry air can cause discomforts, such as stinging eyes or an irritated nose. People with asthma may even experience increased health problems. Static electricity also causes an unpleasant feeling. The Evap provides a higher humidity. The indoor climate becomes healthy again and the comfort in the home improves. The air humidifier is placed directly downstream of the ventilation appliance in the duct that delivers fresh outdoor air to the rooms. Any central ventilation system can be equipped with it.

Features

The Evap is a safe and energy-efficient air humidifier. It works on the basis of the natural water evaporation process (adiabatic). The dry air flows through a water-absorbing glass fibre matrix and takes up the water vapour from the humid surface. That increases the relative humidity of the incoming ventilation air. The built-in heater increases the capacity and the performance, but only if it is necessary. This is a very efficient and low-energy process. The humidifier does its job fully automatically and silently. You can check its operation through an optional Evap Controller. The Evap is directly connected to the water mains. The humidifier comes as standard with a Legiosafe water filter to preclude Legionella contamination and to guarantee a safe and healthy indoor climate.

The advantages at a glance

- For healthy and comfortable living and working conditions
- Increases the comfort in the dwelling
- Operates completely automatically
- Safe to use
- Simple installation and maintenance
- Fits any central ventilation system

Safe and healthy humidification

BRINK

Air for Life



Air Comfort

Adds warmth or freshness
to the ventilation air

Postheating or postcooling

The Air Comfort system module is part of the central ventilation system. Together with the ventilation appliance, the Air Comfort supplies fresh ventilation air with additional warmth or additional coolness, known as postheating or postcooling. That enhances the occupant's temperature comfort experience.

Features

The compact system module can be connected to almost any hot water installation, such as a central heating boiler, district heating or a heat pump. The system fan moves ventilation air and ambient air through the appliance, where the heat exchanger warms it. If cold water is available, the Air Comfort can be used for cooling. The exchanger is installed in such a manner that condensate can easily be drained. Cooling through a ventilation system requires that all channels are insulated and provided with a vapour barrier.

Control

The various operating modes can be set with a multiple switch. In addition, the Air Comfort can be turned into a smart system by equipping it with one or several CO₂ sensors (up to 4) so fresh air is automatically supplied to your home.

Wonderfully agreeable
temperature in the home

The advantages at a glance

Increased temperature comfort

Suitable for post-heating and post-cooling

Highly compact installation

Can be combined with Brink ventilation system

BRINK

Air for Life

Demand control ventilation

Ventilating needed

Efficient and silent ventilation

Demand flow ventilation makes it possible to gear the ventilation need to the current air quality in the habitable rooms. In each room, an indoor air quality sensor measures the CO₂ concentration in the space. If the air quality is satisfactory in every room or zone, basic ventilation suffices. If the air quality in the living room deteriorates, for instance because there are many people in the living room, the ventilation rate is automatically increased.

A humidity sensor (RH) detects a quick increase of the relative humidity due to cooking/showering. Then the ventilation system is switched to the highest setting. When the humidity drops again, the appliance automatically switches back after 20 minutes.

Demand ventilation 2.0

Demand flow ventilation 2.0 by Brink is even more advanced. It distributes the supply air to the dwelling between the living zone and the sleeping zone. A specially developed 3-way valve sends the air to the bedrooms or the living room or both on the basis of the air quality measured in the zones or in the individual rooms. If the preset basic ventilation mode is not sufficient for the desired air quality, the ventilation air quantity is gradually increased. Since the ventilation air is only sent to the zone where it is demanded, the total ventilation flowrate is lower and that means additional energy savings. As a result, the ventilation appliance has to displace less air and the installation sound decreases by approximately 6-8 dB(A). That is important with a view to the requirements of the Building Decree. A maximum of eight CO₂sensors can be connected to the system, which makes it possible to measure in multiple rooms.

In addition to demand ventilation on the basis of air quality, it can also be based on timer control (Air Control).

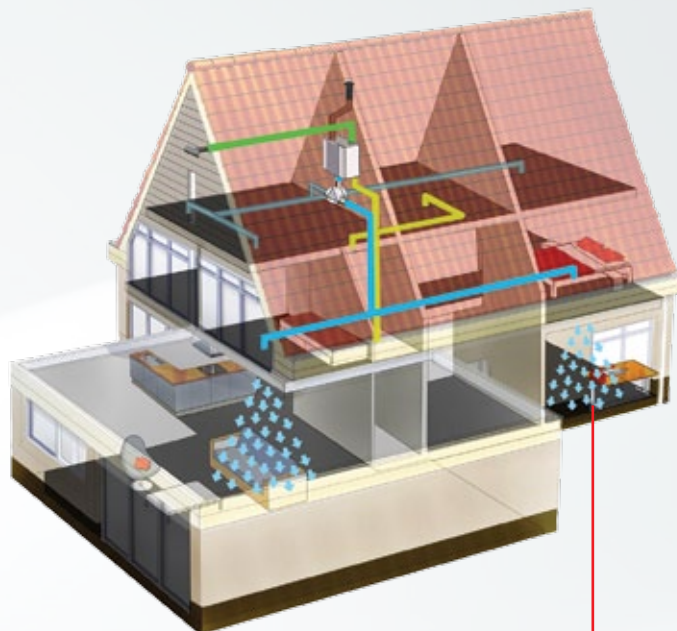

Demand ventilation 2.0:
Increased living room ventilation during the day

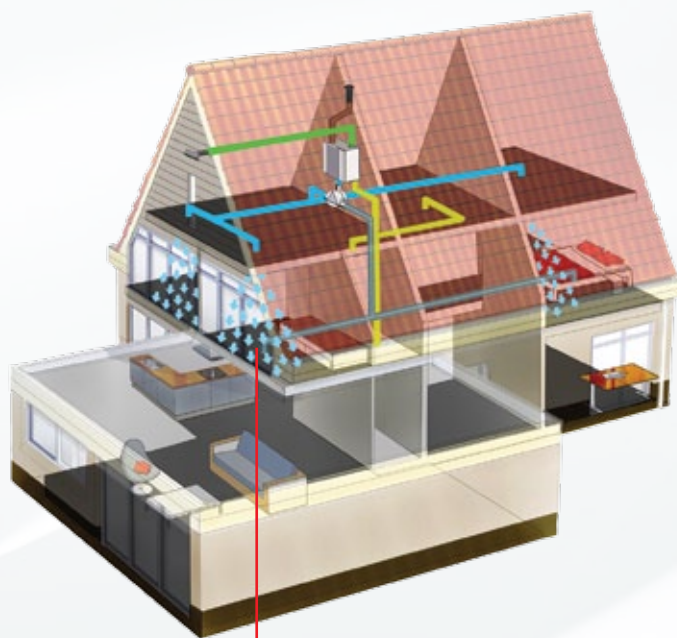

Demand ventilation 2.0:
Increased bedroom ventilation during the night

The advantages at a glance

Guaranteed air quality with CO₂ control

Appliance sound reduction 6-8 dB(A)

Reduced air quantities saves up to 60% energy

Can be combined with the Flair, Renovent Excellent and Renovent Sky

For enhanced comfort, energy and noise reduction

BRINK

Air for Life



Brink Home

Remote control for the occupant

Brink home module and app

Brink Home lets you ventilate when it is needed or desired. That ensures optimal and efficient use of the ventilation system. Brink Home consists of the Brink Home Module and the Brink Home App, linked with the ventilation appliance, optionally equipped with the Air Control unit. That makes the Brink appliances accessible through any (W)LAN router or the Brink Portal Server. The Brink Home App for smartphone and tablet is available for Android and iOS.

Everything remote

The occupant has remote access to the ventilation system in the home. This is routed through the internet or the local network and via smartphone, tablet or PC. The system is fully automatic. The occupant may also set certain functions. That may include setting the ventilation mode (holiday, absent, present, cooking/showering). In addition, the occupant also receives information via the PC or app about, for example, the CO₂ percentage in the home and a message for cleaning or replacement of filters.

Efficient service

Brink Home is extremely handy for service purposes. The occupant receives a warning on his PC or app about any malfunction or need for maintenance. The occupant can then directly transmit the error message to the installer and give the latter permission for remote access to see what is wrong. This enables fast and efficient work for both the installer and the occupant.

Extension to ventilation appliances

Brink Home is optionally available for all appliances: Flair, Renovent Excellent, Renovent Sky and Air 70, and it is ready for use on the Flair Plus. For Renovent appliances, an external module (eModule) is available, for the Air 70 an internal module (iModule) is used.



The advantages at a glance

- For healthy and comfortable living and working conditions
- Ease and comfort for the occupant
- Remote control
- Optimum use of system capabilities
- Energy costs savings
- Easy to install
- Service-friendly

Optimum use and efficient service

Control options

Fully automatic or manual

Make it as easy as possible for yourself

Multiple switch with filter indication

The multiple switch has a filter indication LED light. This light indicates when the filter has to be cleaned.



Multiple switch with filter indication

Air Control

The Air Control is a control module with timer control. It offers more comfort and even higher energy savings.



Air Control

Wireless remote control

The wireless remote control includes an RF transmitter with two or four settings and an RF receiver. The transmitters with two and four settings both have a filter indication LED light. When the filter needs to be cleaned, the light will come on.



RF transmitters

CO₂ sensor

A CO₂ sensor can be used to tune the ventilation control to the current CO₂ concentration.



CO₂ sensor

RH sensor

The RH sensor will notice a sudden increase of the relative humidity in a space due to, for instance, cooking or showering.



RH sensor

Brink Connect (Modbus)

With the Modbus interface Brink Connect, the Flair, Renovent Excellent and Renovent Sky can communicate with a Modbus network such as a building management system. For example, you can monitor and control appliances from one central point and use the data for analysis of the energy performance of buildings.

BRINK

Air for Life



Air distribution systems

Brink has the total package

The most complete air distribution system

Air Excellent System circular and semicircular

The Air Excellent System is a plastic air distribution system for the supply and exhaust of ventilation air. It is a modular air distribution system with flexible ducts, various fittings and manifolds. The system is available for a variety of flow rates in the variants round and semicircular. Moreover, the semicircular Air Excellent System is 30% less high than conventional air distribution systems. Both duct types can be incorporated in concrete. The Air Excellent System is delivered through the Ubbink-Centrotherm Group which, just like Brink, is a division of Centrotec Sustainable AG.

Operation

Two manifolds are placed between the ventilation unit and the supply and exhaust points to ensure optimum air distribution. These manifolds may be fitted with internal sound insulation. The ducts lead the air from and to the various rooms.

Manifolds

The synthetic manifold is available in two series: 200 and 800 Series. The 200 Series is available with 6 and 8 connections and the units can be stacked and coupled. The 800 Series comes with 8, 16 or 24 connections. The metal manifold is available in various versions.

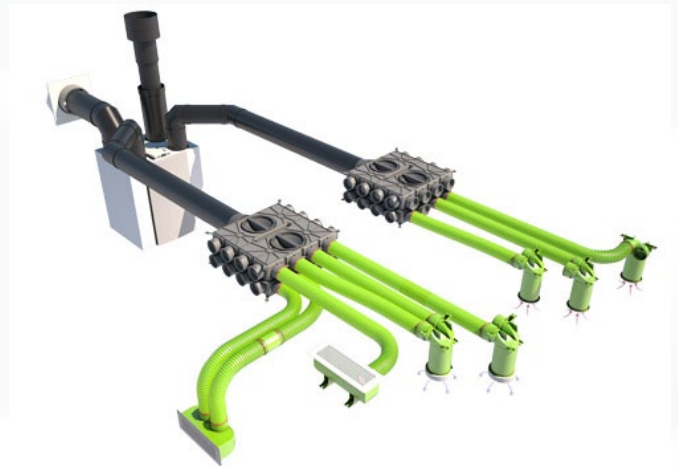

The advantages at a glance

Initial adjustment from the drawing board with online configurator

Easy and quick to install: 'plug and play'

Lower risk of installation errors

No crosstalk between spaces

High airtightness

Maintenance friendly

Antistatic and antibacterial

BRINK

Air for Life

General

Balanced heat recovery ventilation

The fresh air supply and the foul air exhaust are balanced. The air flows do not mix, but they remain separate. At lower outdoor temperatures, up to 95% of the heat is extracted from the exhaust air and transferred to the incoming cold outdoor air. This means the cold outdoor air is heated 'for free'. If the outdoor air temperature is higher than the indoor air temperature, it works the other way around. This gives Brink appliances the highest EPG reduction and, also as a result of the application of Constant Flow fans, they get the highest EPG score.

Constant Flow Control

Application of the unique Constant Flow principle in all Renovent appliances guarantees the preset air flowrates and the balance between supply and exhaust air. That always guarantees the high efficiency, independent of the resistance in the ducts system or the filter fouling degree. It also makes initial adjustment simple and thus cheaper.

Brink filters

The Flair, Renovent Excellent, Renovent Sky and Air 70 come as standard with filters. Brink offers a filter solution for every situation. Use genuine Brink filters for the best result and excellent air in your home. Brink filters are ordered easily from your installer.

Bypass for night ventilation

In summer, the 100% bypass contributes to improved comfort and it is controlled automatically on the basis of the measured indoor and outdoor temperatures.

Preheater

The intelligent frost protection with preheater guarantees the high efficiency, also at extremely low outdoor temperatures. Compared to other frost protection solutions, it provides additional savings on the energy bill.

Technical specifications

Appliance type	Pure induct	Evap	Air Comfort
Air volume [m ³ /h]	Maximum 600	Maximum 600	Maximum 450
Energy Consumption [W]	4	Maximum 800	72
Voltage	230 V/ 50 - 60 Hz	230 V/ 50 - 60 Hz	230 V/ 50 - 60 Hz
Duct connection [mm]	Ø 125 - Ø 250 (using reducers)	Ø 150 - Ø 200	Ø 250
H X W X D [mm]	361 x 765 x 393	335 x 344 x 258	429 x 676 x 640
Weight [kg]	7.1	6	40
Maximum humidification capacity [l/h]		4	
Maximum water consumption [l/h]		5	
Minimum supply water pressure [bar]		1.5	
Water drain		PVC 15 mm hose	
Water connection [mm]		¾"	22
Heating capacity at 45/35 °C water [kW]			approximately 2.8
Cooling capacity at 7/11 °C water [kW]			approximately 1.75

BRINK

Air for Life

Technical specifications

* On our website www.brinkclimatesystems.com you will find the complete technical specifications according to Ecodesign.

** PHI = Passive House Institute Certificate

Appliance type	Flair				
	225	325	325 Enthalpy	400	400 Enthalpy
Ventilation capacity at 150 Pa [m³/h]	Maximum 225	Maximum 325	Maximum 325	Maximum 400	Maximum 400
Ecodesign energy class*					
• Manual					
• Timer					
• Central demand control					
• Local demand control					
SPI EN-13141-7 [W/m³/h]	0.17	0.15	0.16	0.17	0.17
Temperature performance EN-13141-7 [%]	92	92.5	82.3	92.1	80.5
SPI PHI [W/m³/h]**	-	0.21	0.15	0.20	0.16
Temperature efficiency PHI [%]**	89	91	80	89	80
Sound power casing emission at Q _v 70% and 50 Pa [dB]	39	41	41	50	50
Dimension duct connection [mm]	Ø 125	Ø 160	Ø 160	Ø 180	Ø 180
H x W x D version 4/0, L/R [mm]	650 x 600 x 455	650 x 750 x 560	650 x 750 x 560	650 x 750 x 560	650 x 750 x 560
H x W x D version 2/2, L/R [mm]	-	710 x 750 x 560	710 x 750 x 560	710 x 750 x 560	710 x 750 x 560
Weight [kg]	29	37	37	37	37
Constant Flow Control	✓	✓	✓	✓	✓
Standard 100% bypass	✓	✓	✓	✓	✓
Built-in preheater	✓	✓	✓	✓	✓
Connection for RH sensor	✓	✓	✓	✓	✓
Connection for CO ₂ sensors (Plus)	✓	✓	✓	✓	✓
Connection provisions for 2-zone demand flow	✓	✓	✓	✓	✓
Connection for Air Control	✓	✓	✓	✓	✓
Connection for Modbus	✓	✓	✓	✓	✓
Connection for eBus	✓	✓	✓	✓	✓
Suitable for Brink Home (Plus)	✓	✓	✓	✓	✓

Appliance type	Renovent Excellent			
	180	300	400	450
Ventilation capacity at 150 Pa [m³/h]	Maximum 180	Maximum 300	Maximum 400	Maximum 450
Ecodesign energy class*				
• Manual				
• Timer				
• Central demand control				
• Local demand control				
SPI EN-13141-7 [W/m³/h]	0.31	0.21	0.24	0.28
Temperature performance EN-13141-7 [%]	82	86	85	84
SPI PHI [W/m³/h]**		0.26	0.29	
Temperature efficiency PHI [%]**		84	84	
Sound power casing emission at Q _v 70% and 50 Pa [dB]	42	44	48	51
Dimension duct connection [mm]	Ø 125	Ø 160	Ø 180	Ø 180
H X W X D [mm]	600 x 560 x 302	765 x 677 x 564	765 x 677 x 564	765 x 677 x 564
Weight [kg]	25	38	38	38
Constant Flow Control	✓	✓	✓	✓
Standard 100% bypass	(bypass functionality)	✓	✓	✓
Built-in preheater		✓	✓	✓
Connection for RH sensor	✓	✓	✓	✓
Connection for CO ₂ sensors (Plus)	✓	✓	✓	✓
Connection provisions for 2-zone demand flow	✓	✓	✓	✓
Connection for Air Control	✓	✓	✓	✓
Connection for Brink Connect (Modbus)	✓	✓	✓	✓
Connection for eBus	✓	✓	✓	✓
Suitable for Brink Home	✓	✓	✓	✓















BRINK

Air for Life

Technical specifications

* On our website www.brinkclimatesystems.com you will find the complete technical specifications according to Ecodesign.

** PHI = Passive House Institute Certificate

Appliance type	Renovent Sky			Air
	150	200	300	70
Ventilation capacity at 150 Pa [m ³ /h]	Maximum 150	Maximum 200	Maximum 300	Maximum 70
Ecodesign energy class*	-	-	-	
• Manual				-
• Timer				-
• Central demand control				-
• Local demand control				
SPI EN-13141-7 [W/m ³ /h]	0.27	0.26	0.24	0.2 [EN-13141-8]
Temperature performance EN-13141-7 [%]	89	83	84	80 [40 m ³ /h]
SPI PHI [W/m ³ /h]**	0.35	0.35	0.31	-
Temperature efficiency PHI [%]**	84	84	85	-
Sound power casing emission at Q _v 70% and 50 Pa [dB]	38	49	44	40
Dimension duct connection [mm]	Ø 125	Ø 160	Ø 150 and 160	-
H X W X D [mm]	198 x 660 x 1000	198 x 660 x 1000	310 x 644 x 1185	398 x 398 x 665
Weight [kg]	24.5	24.5	37	12
Constant Flow Control	✓	✓	✓	-
Standard 100% bypass	✓	✓	✓	✓
Built-in preheater	✓	✓	-	✓
Connection for RH sensor	✓	✓	✓	✓
Connection for CO ₂ sensors (Plus)	✓	✓	✓	✓
Connection for 2-zone demand flow	✓	✓	✓	-
Connection for Air Control	✓	✓	✓	-
Connection for Modbus with Brink Connect	✓	✓	✓	-
Connection for Modbus with Plus pcb	-	-	-	✓
Connection for eBus	✓	✓	✓	✓
Suitable for Brink Home	✓	✓	✓	✓

BRINK

Air for Life

Brink ventilation systems



Health

Removal of harmful substances, supply of oxygen-rich air



Wellness

Pleasant and healthy living



Comfort

Fresh air without draughts or chills



Ease

Relying on healthy air without any effort



Sustainability

Savings on energy costs and reduction of CO₂ emissions