



Air for life

Installation regulations

Brink Air Control- Ventilation
English



Contents

1 User manual.	3	11 Appendix: Standard settings weekly programs.	28
1.1 Description Brink Air Control- Ventilation.	3	11.1 Standard program P1.	28
1.2 Symbols used.	3	11.2 Standard program P2.	29
2 Technical specification.	4	11.3 Standard program P3.	30
2.1 General product specification.	4		
2.2 Environment influences.	4		
2.3 Overview operational controls.	5		
2.4 Overview display version main screen.	5		
2.5 Ventilation modes.	6		
3 Precautionary measures and safety instructions.	7		
3.1 General.	7		
3.2 During placement.	7		
3.3 During use.	7		
3.4 During maintenance.	8		
3.5 For the environment.	8		
4 Assembly and installation (to be performed by the installer).	9		
4.1 Assembly.	9		
4.1.1 Disconnecting the operational module from the wall bracket.	9		
4.1.2 Mounting the wall bracket.	9		
4.1.3 Electrical connection.	10		
4.1.4 Replacing the operational module in the wall bracket.	10		
4.2 Installation.	11		
4.2.1 Setting language.	11		
4.2.2 Setting time.	12		
4.2.3 Setting date.	13		
5 Description of operation; manner of use.	14		
5.1 Navigation: general description.	14		
5.2 Weekly programmes P1, P2 and P3.	15		
5.2.1 Standard settings P1, P2 and P3.	15		
5.2.2 Creating a P1 program.	16		
5.2.3 Creating a P2 program.	17		
5.2.4 Creating a P3 program.	18		
5.3 Activating program type (P1, P2 or P3).	19		
5.4 Temporarily overriding program.	19		
5.5 Overriding program for a longer period of time.	19		
5.6 Setting ventilation mode values.	20		
5.7 Retrieving settings.	21		
5.8 Factory setting connected device.	21		
6 Maintenance.	22		
6.1 General maintenance.	22		
6.2 Cleaning or replacing filter.	22		
6.2.1 Filter notification.	22		
6.2.2 Removing, cleaning or replacing.	22		
6.2.3 Re-setting filter notification.	23		
7 Dismanteling.	24		
8 Repair.	25		
9 Environment.	26		
10 Troubleshooting and guarantee.	27		
10.1 Troubleshooting.	27		
10.2 Guarantee.	27		

1 User manual

Dear client,

Thank you for buying the Brink Air Control- Ventilation. This user's manual contains all required information to quickly become familiar with the product. We kindly request you to carefully go through this information before using the product. This user's manual is intended for the Brink Air Control- Ventilation installer and end user. You can retrieve the required information from the user's manual via the table of contents.

This is an extended user's manual. A Quick Start Guide is available, in addition to this user's manual. Take good care of this user's manual! For more information or ordering manuals, please contact:

Brink Climate Systems B.V.
Mailbox 11
NL-7950 AA, Staphorst, The Netherlands
T: +31 (0) 522 46 99 44
F: +31 (0) 522 46 94 00
E: info@brinkclimatesystems.nl
www.brinkclimatesystems.nl

1.1 Description Brink Air Control- Ventilation

Intended and unintended use

The Brink Air Control- Ventilation should be used in combination with products that have been approved by Brink Climate Systems B.V.

Brink Climate Systems B.V. cannot be held responsible for possible damage caused by improper, incorrect or unwise use. It is important that one understands this user's manual completely.

Working with other devices

The Brink Air Control- Ventilation is connected to other devices. The HRU (Heat Recovery Unit) is co-dependent on these devices' operation for its proper functioning. These devices' presence and proper functioning are prerequisites for using the Brink Air Control- Ventilation.

1.2 Symbols used



Warning!

The user can (seriously) injure himself or seriously damage the product. A warning is indicative of a risk of damage to the user or product, if the user does not execute the procedures carefully.



Careful!

The product can be endangered. "Careful" is indicative of a risk of damage to the product, if the user does not execute the procedures carefully.



Take note!

A remark with supplementary information for the user. A remark draws the user's attention to possible problems.

2 Technical specification

2.1 General product specification

Product description

Name: Brink Air Control- Ventilation

Technical product specifications

Electricity: 15 to 24 Volt

Power consumption: 1,5 Watt

Protection class: IP30

Power reserve: > 48 hours

Ambient conditions

Ambient temperature: 0 °C to 50 °C

Storage temperature: -20 °C to 60 °C

Humidity: 10% to 90%

Other: Exclusively for indoor use

2.2 Environment influences

The Brink Air Control- Ventilation should be placed and used in a space with the correct ambient conditions for proper operation. The Brink Air Control- Ventilation may only be mounted on the indoors, but not on the vicinity of a heat source, a radiator, in a draft or in a humid environment. The Brink Air Control- Ventilation may also not be exposed to direct radiation heat (sun light). The Brink Air Control- Ventilation may also not be mounted in the vicinity of a magnetic field. This could damage internal components.

2.3 Overview operational controls

The Brink Air Control- Ventilation has a number of buttons with which the device can be operated:

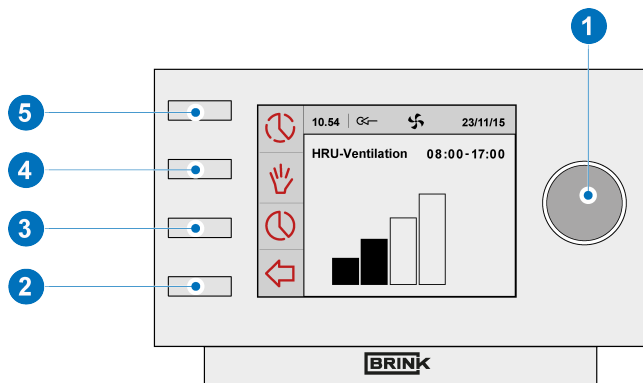

- 1 = Setting knob
- 2 = Return key
- 3 = Setting & activating timer programme
- 4 = Manual control key
- 5 = Bypassing the timer programme

2.4 Overview display version main screen

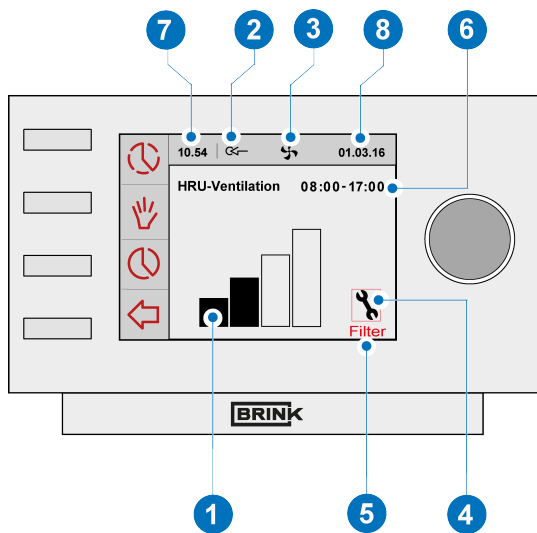

- 1 = Flow rate indicator
- 2 = eBus connection indicator
- 3 = Fan indicator
- 4 = Fault symbol
- 5 = Filter message
- 6 = Current time block
- 7 = Current time
- 8 = Current date (day/ month/ year)

2.5 Ventilation modes

The Brink Air Control- Ventilation has four ventilation modes. You can activate a ventilation mode yourself (for more information see → [Description of operation; manner of use](#) page 14). You can adjust every ventilation mode yourself (for more information → [Setting ventilation mode values](#) page 20). You can retrieve the set values at the Device information menu (see below).

	1
	2
	3

Ventilation modes

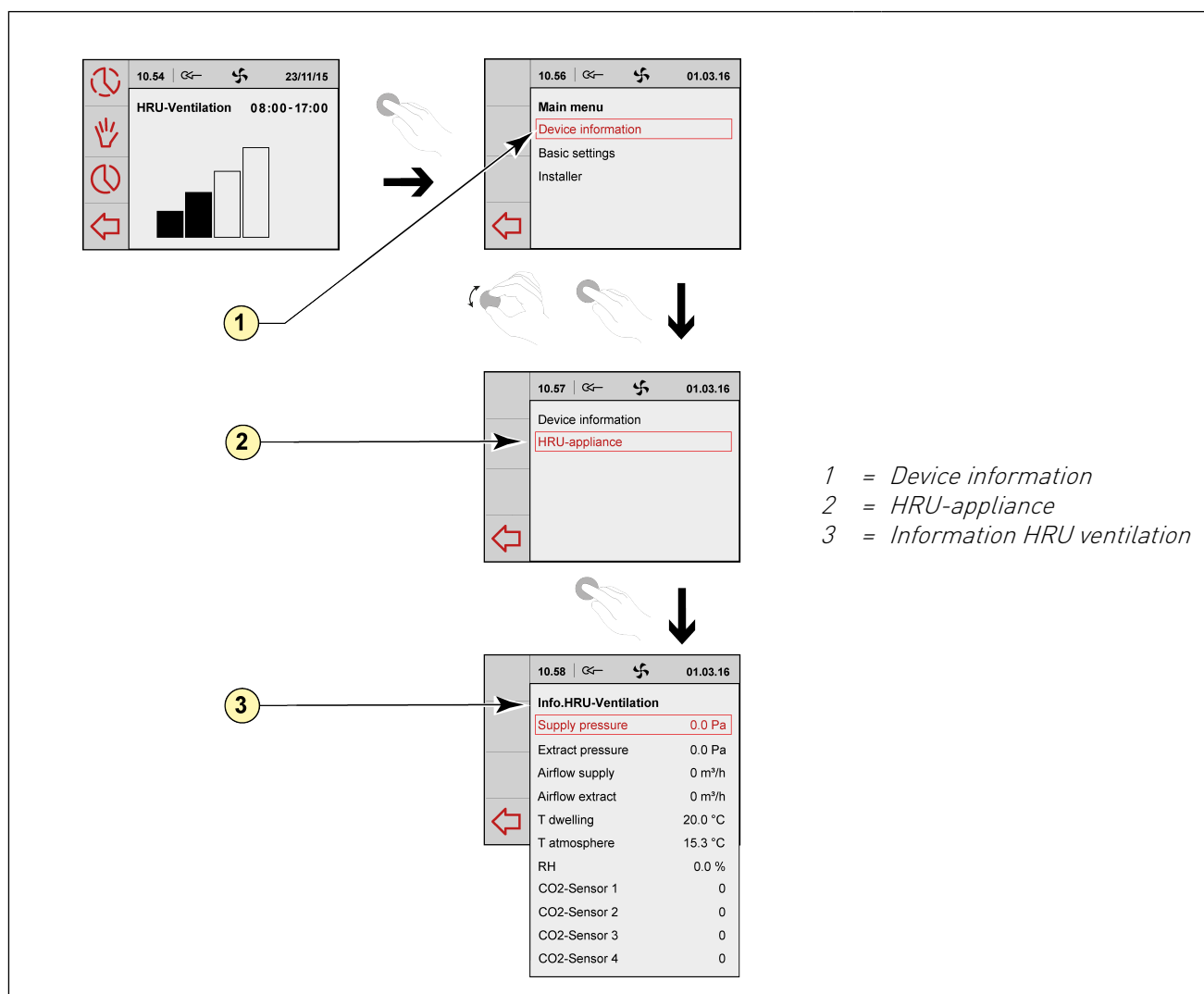

3 Precautionary measures and safety instructions

3.1 General

Warning!

The installation and assembly activities required to commission your Brink Air Control- Ventilation should be performed by an installer approved by Brink Climate Systems B.V.



Immediately remove the power from your Brink Air Control- Ventilation by removing the connected device's plug from the socket, if:

- Parts of the Brink Air Control- Ventilation lie open, are pierced or had fallen hard;
- The power cable is damaged;
- The screen is cracked or broken.

Then contact Brink Climate Systems B.V. or your supplier.

Take note!



- Never use parts other than original parts.
- Only use the Brink Air Control- Ventilation indoors, at temperatures between 0 °C and 50 °C and with a relative humidity between 0% and 90%.
- All settings (excluding the filter message) will be lost if the Brink Air Control- Ventilation breaks down or if the factory settings are reset. There is no backup available.

3.2 During placement

Take note!



Assembly and installation should be performed by an installer approved by Brink Climate Systems B.V. The following requirements should be taken into account during placement:

- The Brink Air Control- Ventilation should be placed at a height of approximately 1.65 meters above the floor;
- The Brink Air Control- Ventilation may not be covered, for example, by a curtain or a cabinet;
- Consult paragraph → [Environment influences](#) page 4 for environmental requirements.

3.3 During use



Take note!

Settings, which have not been described in this user's manual, are intended for installers approved by Brink Climate Systems B.V. Do not change these by yourself.

3.4 During maintenance



Careful!

Clean the screen with a soft cloth.
Never apply water and/or (cleaning) liquid to the screen.

3.5 For the environment



Take note!

The Brink Air Control- Ventilation may not be removed as unsorted urban waste, but should be treated separately.

Make enquiries within your own region, where the Brink Air Control- Ventilation can be handed in when use has been terminated. Do not throw away electrical devices or parts, but check if (parts of) the Brink Air Control- Ventilation cannot be handed in, recycled or re-used.

4 Assembly and installation (to be performed by the installer)

Assembly and installation should be performed by an installer approved by Brink Climate Systems B.V.

4.1 Assembly

You should perform the steps, described in paragraph (→ [Disconnecting the operational module from the wall bracket](#) page 9) through paragraph (→ [Replacing the operational module in the wall bracket](#) page 10), one by one, to assemble the Brink Air Control- Ventilation.

4.1.1 Disconnecting the operational module from the wall bracket

Disconnect the operational module from the wall bracket. Perform the following actions :

- Slide the control unit upward over the two guide profiles of the wall bracket until the control unit can be taken off.

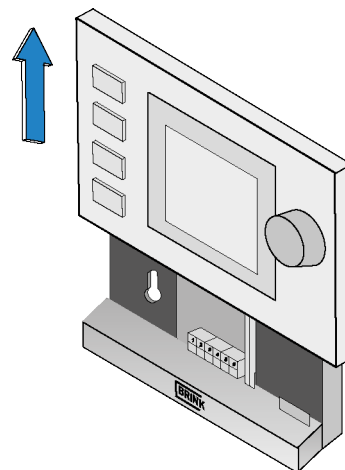

4.1.2 Mounting the wall bracket

The wall bracket can be attached to a wall box (Ø 55 mm) or can be directly mounted on the wall with screws and plugs.

- Screw the wall bracket onto the wall in the correct position. Here one must use the mounting holes in the wall bracket.

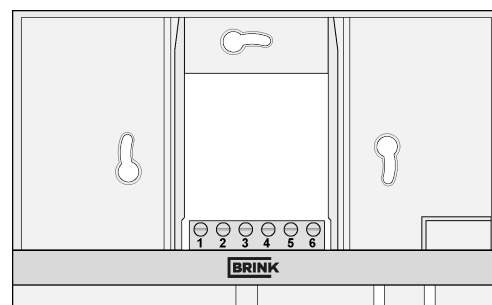

Take note!

Consult (→ [During placement](#) page 7) for more information on placing the Brink Air Control-Ventilation.

4.1.3 Electrical connection

The following actions should be performed to connect the Brink Air Control- Ventilation electrically:

- Feed the two-core wire (from the device to be connected) through via opening at the back of the wall bracket.
- Check that the cables' ends have been stripped in the correct manner. If this is not the case, do so.
- Screw the cable to the terminal No. 1 and No. 2. Consult the installation instructions of the device to be connected, for more information on the correct connection.

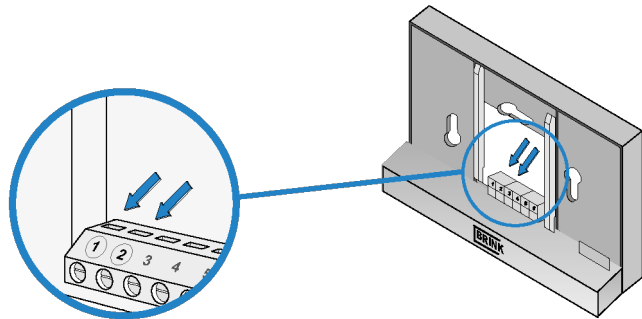

4.1.4 Replacing the operational module in the wall bracket

Place the operational in the wall bracket mounted on the wall. Perform the following actions for this :

- Slide the control unit downward over the two guide profiles. Make sure the guide profiles of the wall bracket fit snugly in the cutouts of the control unit provided for that purpose.

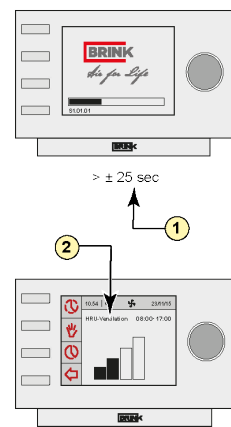
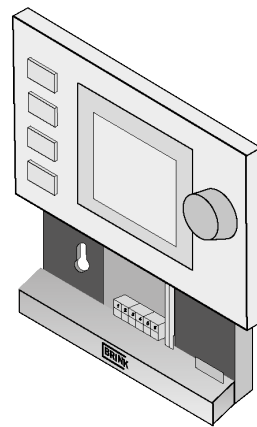
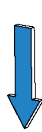

- 1 = ± 25 seconds
- 2 = HRU ventilation

Take note!

The operational module should click onto the wall bracket. Only then is a proper electrical connection established.



At power on the device determines which type of device is connected either a Heat Recovery Unit or an Air Heating Unit followed by an second start-up cycle!

4.2 Installation

4.2.1 Setting language

You can set the language in which the menus are presented. Perform the following actions to set the language:

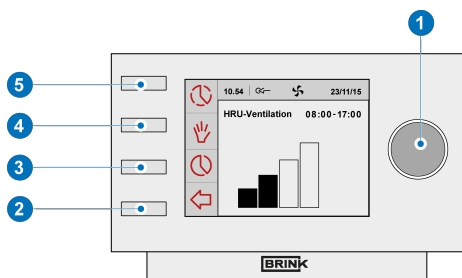

- Press returnkey "2" as many times as necessary to get to the main screen,
- Press setting knob "1"; 'Main Menu' opens,
- Select 'Basic Settings' by turning setting knob "1",
- Press setting knob "1"; 'Basic Settings' opens,
- Select 'Language' by turning setting knob "1",
- Press setting knob "1"; 'Language' opens,
- Select the desired language by turning setting knob "1",
- Press setting knob "1" to set the selected language,
- Press return key "2" as many times as necessary to get to the main screen.

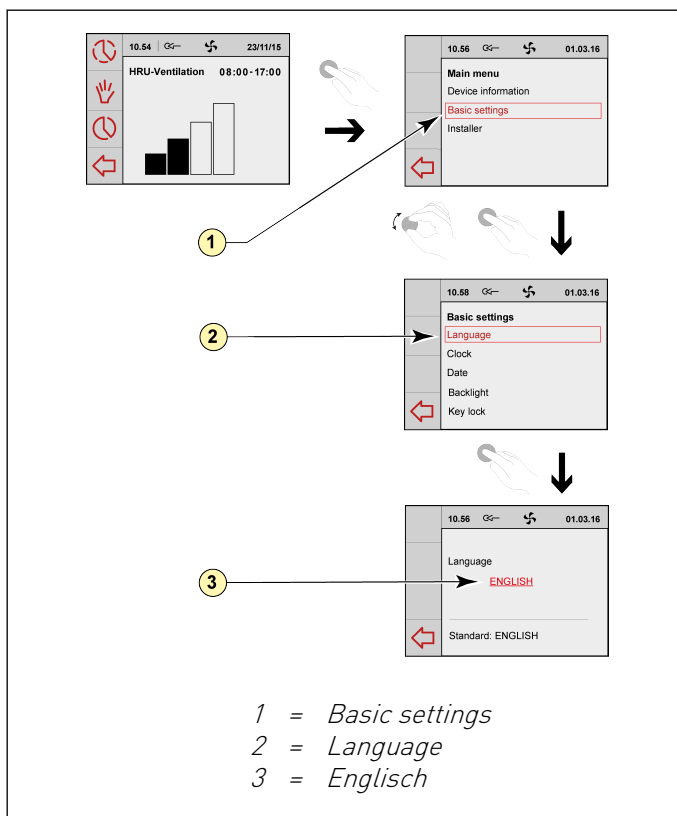

Take note!

The names of the described menu items will not correspond with this user manual's menu items if the Brink Air Control- Ventilation is set to a language other than Dutch.

4.2.2 Setting time

You can set the time. The time is visible on the main screen. The Brink Air Control- Ventilation only has 24 hour representation.

Perform the following actions to set the time :

- Press returnkey "2" as many times as necessary to get to the main screen,
- Press setting knob "1"; 'Main Menu' opens,
- Select 'Basic Settings' by turning setting knob "1",
- Press setting knob "1"; 'Basic Settings' opens,
- Select 'Clock' by turning setting knob "1",
- Press setting knob "1"; 'Clock' opens,
- Change the time by turning setting knob "1",
- Press setting knob "1" to confirm the time,
- Repeat the previous two steps for both the minutes and seconds,
- Press returnkey "2" as many times as necessary to get to the main screen.

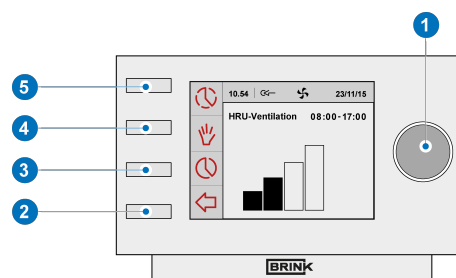

4.2.3 Setting date

You can set the date. The date is visible on the main screen.
Perform the following actions to set the date:

- Press returnkey "2" as many times as necessary to get to the main screen
- Press setting knob "1"; 'Main Menu' opens
- Select 'Basic Settings' by turning setting knob "1"
- Press setting knob "1"; 'Basic Settings' opens
- Select 'Date' by turning setting knob "1"
- Press setting knob "1" 'Date' opens
- Change the day by turning setting knob "1"
- Repeat the previous two steps for both the months and the year
- Press returnkey "2" as many times as necessary to get to the main screen

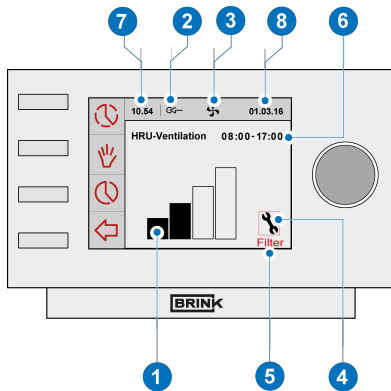
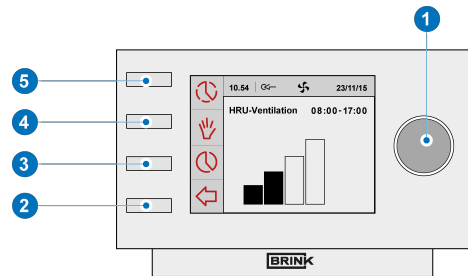

- 1 = Flow rate indicator
- 2 = eBus connection indicator
- 3 = Fan indicator
- 4 = Fault symbol
- 5 = Filter message
- 6 = Current time block
- 7 = Current time
- 8 = Current date

5 Description of operation; manner of use

You can increase or decrease the ventilation mode with the Brink Air Control- Ventilation. You can do this by setting a program. You can temporarily override the program while it is running.

5.1 Navigation: general description

Navigating through menus

The Brink Air Control- Ventilation has menus that you can navigate through. For this you use setting knob "1". You scroll through the menus by turning the setting knob "1". You can open a selected menu-item by pressing the setting knob "1".

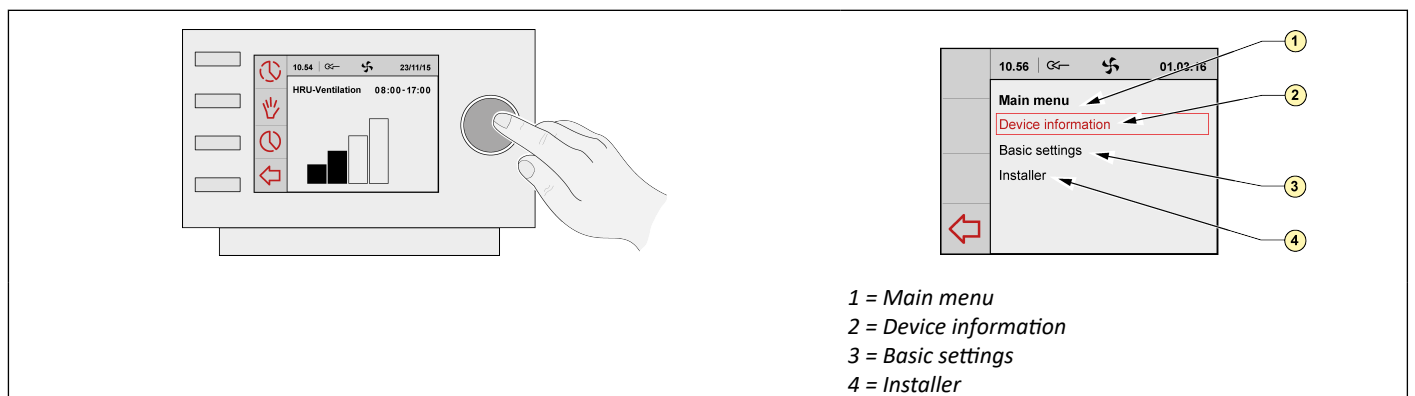
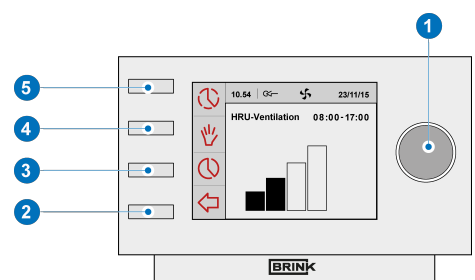

Return to the main screen

The main screen is the Brink Air Control- Ventilation start screen.

You can always return to the main screen by pressing on the return key "2" a few times. The number of times you need to press return depends on how deep you have gone into the menu. U need not be afraid of pressing return too frequently.

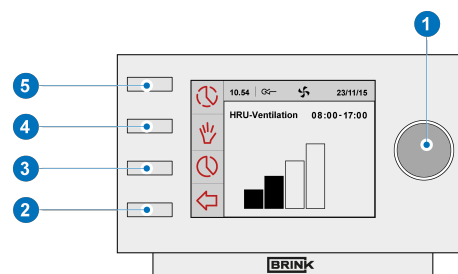

5.2 Weekly programmes P1, P2 and P3

You can programme the regulation of the ventilation mode in a weekly program. You can choose from programs P1, P2 and P3.

Program P1

With this you create a day program for every day of the week.

Program P2

With this you create two day programs.

One day program for weekdays 'mo-fri' and one day program for the weekend 'sa-su'.

Program P3

With this you create seven day programs.

Separately for every day of the week.

5.2.1 Standard settings P1, P2 and P3

The Brink Air Control- Ventilation has standard set weekly programmes. You can find these settings in appendix (→ [Appendix: Standard settings weekly programs](#) page 28).

5.2.2 Creating a P1 program

- Press returnkey "2" as many times as necessary to get to the main screen,
- Press setting & activating time program knob "3"; 'Setting & activating timer programme' opens,
- Select 'P1: week' by turning setting knob "1",
- Press setting knob "1"; 'P1: week' opens.

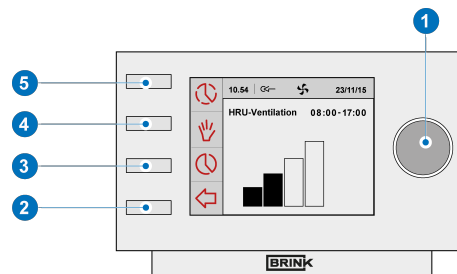

You have a choice from 'Period 1', 'Period 2', 'Period 3', 'Period 4', 'Period 5' and 'Period 6'. Every period is a part of the day in which you can set a ventilation position. Perform the following actions to set period 1:

- Select 'P1' by turning setting knob "1",
- Press setting knob "1"; 'Period 1' opens,
- Select 'Start Time' by turning setting knob "1",
- Press setting knob "1"; 'Start Time' opens,
- Change the start time by turning setting knob "1",
- You have a range of between 3.00u and 2.59u.



If in a period the time is turned back so far that lines appear, that period and the one above it will be deleted.

- Press setting knob "1" to confirm the start time

Now set the ventilation mode for period 1. Perform the following actions for this:

- Select 'Ventilatiestand' by turning "1",
- Press "1", 'Ventilatiestand' opens,
- Set the ventilation mode for period 1 by turning "1",
- Press "1" to confirm the ventilation mode for period 1.

You have set the ventilation mode for period 1. You can set period 2 through 6 in the same manner. A period ends when a new one starts.

5.2.3 Creating a P2 program

- Press returnkey "2" as many times as necessary to get to the main screen,
- Press setting & activating time program knob "3"; 'Setting & activating timer programme' opens,
- Select 'P2: week/weekend' by turning setting knob "1",
- Press setting knob "1"; 'P1: week/weekend' opens.

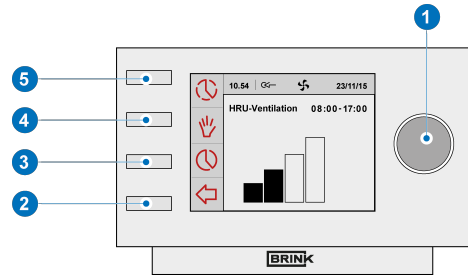

You can choose between 'Week' and 'Weekend'. With 'Week' you can set a day program for Monday through Friday. With 'Weekend' you can set a day program for Saturday and Sunday.

Week

- Select 'Week' by turning setting knob "1",
- Press setting knob "1"; 'Week' opens,

(* You have a choice from 'Period 1', 'Period 2', 'Period 3', 'Period 4', 'Period 5' and 'Period 6'. Every period is a part of the day in which you can set a ventilation mode.

Perform the following actions to set period 1:

- Select 'Period 1' by turning setting knob "1",
- Press setting knob "1"; 'Period 1' opens,
- Select 'start time' by turning setting knob "1",
- Press setting knob "1"; 'start time' opens,
- Change 'start time' by turning setting knob "1"; You have a range of between 3.00 hrs and 2.59 hrs,
- Press setting knob "1" to confirm start time.

Now set the ventilation mode for period 1. Perform the following actions for this:

- Select 'Ventilatiestand' by turning setting knob "1"
- Press setting knob "1"; 'Ventilatiestand' opens
- Set the ventilation mode for period 1 by turning setting knob "1"
- Press setting knob "1" to confirm the airflow for period 1

You have set the ventilation mode for period 1 You can set period 2 through 6 in the same manner. A period ends when a new one starts.

Weekend

- Follow the steps from paragraph 5.3.3, until you have a choice between 'Week' and 'Weekend'
- Select 'Weekend' by turning setting knob "1"
- Press setting knob "1"; 'Weekend' opens
- Continue the steps from paragraph 5.3.3 at (*)

5.2.4 Creating a P3 program

- Press return key "2" as many times as necessary to get to the main screen,
- Press setting & activating time program knob "3"; 'Setting & activating timer programme' opens,
- Select 'P3: day' by turning setting knob "1",
- Press setting knob "1"; 'P3: day' opens.

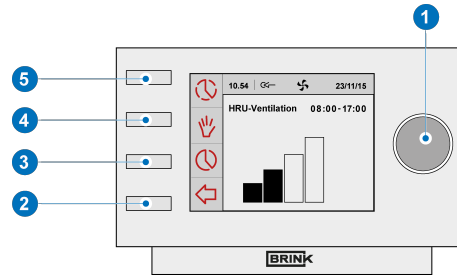

[*] You can choose from the days between 'Monday' through 'Sunday'. You perform the following steps to set a day program for Monday:

- Select 'Monday' by turning setting knob "1",
- Press setting knob "1"; 'Monday' opens,

You have a choice from 'Period 1', 'Period 2', 'Period 3', 'Period 4', 'Period 5' and 'Period 6'. Every period is a part of the day in which you can set a ventilation position.

- Select 'Period 1' by turning setting knob "1",
- Press setting knob "1"; 'Period 1' opens,
- Select 'Start time' by turning setting knob "1",
- Press setting knob "1"; 'Start time' opens,
- Change 'Start time' by turning setting knob "1"; You have a range of between 3.00u and 2.59u,
- Press setting knob "1" to confirm 'Start time'.

Now set the ventilation mode for period 1.

Perform the following actions for this:

- Select 'Ventilation mode' by turning setting knob "1",
- Press setting knob "1"; 'Ventilatiestand' opens,
- Set the ventilation mode for period 1 by turning setting knob "1",
- Press setting knob "1" to confirm the ventilation mode for period 1.

You have set the ventilation mode for period 1. You can set period 2 through 6 in the same manner. A period ends when a new one starts.

If you have created a day program for Monday, you can do the same for the other days of the week. Then repeat the steps from paragraph 5.3.4, but, after (*) choose another day instead of 'Monday'.

5.3 Activating program type (P1, P2 or P3)

The Brink Air Control- Ventilation has three types of weekly programs P1, P2 and P3. You can program the weekly programs by yourself, for more information see paragraph .→ [Weekly programmes P1, P2 and P3](#) page 15.

Perform the following actions if you wish to program one of the weekly programs:

- Press returnkey **"2"** as many times as necessary to get to the main screen,
- Press setting & activating time program knob **"3"**; 'Setting & activating timer programme' opens,
- Select 'Active program' by turning setting knob **"1"**,
- Press setting knob **"1"**; 'Active program' opens,
- Select 'P1, P2 or P3' by turning setting knob **"1"**,
- Press setting knob **"1"** to activate P1, P2 or P3.

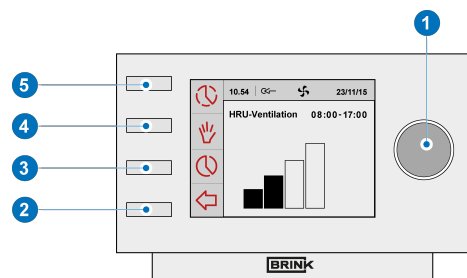

5.4 Temporarily overriding program

You can temporarily override the program. You need to perform the following actions for this :

- Press returnkey **"2"** as many times as necessary to get to the main screen,
- Press knob **"5"**; 'Bypassing the timer programme' opens,
- Turn setting knob **"1"** to temporarily set the ventilation mode.

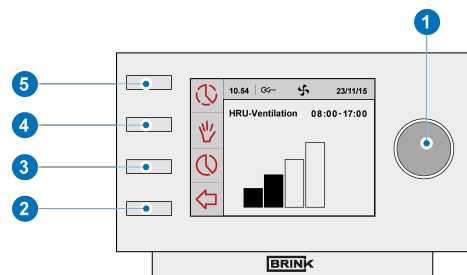

Take note!

It is stated at the top of your screen, how long the newly set ventilation mode applies. The program will be enabled again after this period of time. The override period will be 30 minutes if you overruled the device in the maximum position. You can also undo this by pressing returnkey **"2"**. Return key **"2"** can not be operated until some 10 seconds after the latest setting!

5.5 Overriding program for a longer period of time

A set program can be overridden manually, for example, during holidays. Perform the following actions to overrule the program:

- Press return key **"2"** as many times as necessary to get to the main screen,
- Press knob **"4"** and 'Manual' appears in the display,
- Turn setting knob **"1"** to set the ventilation position,
- The manual position now overrules the programme. Press return key **"2"** if you wish to undo the manual position. Return key **"2"** can not be operated until some 10 seconds after the latest setting!

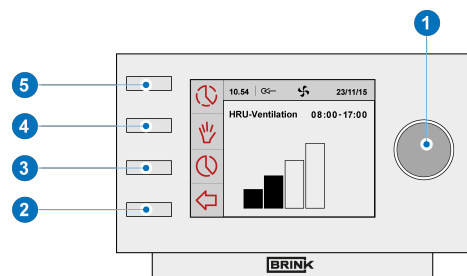

5.6 Setting ventilation mode values

You can set a ventilation mode's value by yourself.
Perform the following actions for this:

- Press returnkey "2" as many times as necessary to get to the main screen,
- Press setting knob "1"; 'Main Menu' opens,
- Select 'Installer' by turning setting knob "1",
- Turn setting knob "1" to select the desired appliances,
- Press setting knob "1" to confirm the desired appliance (or select the choice HRV appliance if only one appliance is connected),
- Select 'Device settings' by turning setting knob "1",
- Press setting knob "1"; 'Device settings' opens,
- Select 'Airflow 0 (Holiday)' by turning setting knob "1".

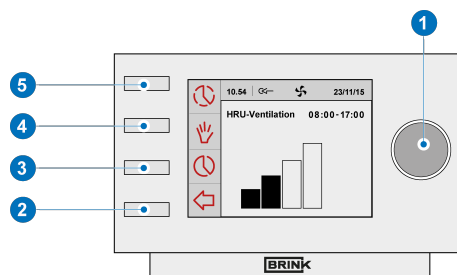

Take note!

'Airflow 0 (Holiday)' refers to ventilation mode



'Airflow 1 (Reduced)' refers to ventilation mode



'Airflow 2 (Normal)' refers to ventilation mode



'Airflow 3 (High)' refers to ventilation mode



- Set Airflow 0 (Holiday) by turning setting knob "1",
- Press setting knob "1" to confirm the set value for Airflow 0 (Holiday).

You can set debit 1 through 3 in the same manner as described above for Airflow 0 (Holiday).



Take note!

You can not feed in a value, lower than value of a lower Airflow position, for a higher (Airflow Holiday < Airflow Reduced < Airflow Normal < Airflow High).

5.7 Retrieving settings

You can retrieve the current settings from the Brink Air Control- Ventilation:

- Press returnkey **"2"** as many times as necessary to get to the main screen
- Press setting knob **"1"** 'Main Menu' opens
- Turn setting knob **"1"** to select the desired appliances
- Press setting knob **"1"** to confirm the desired appliance (or select the choice HRV appliance if only one appliance is connected).
- Select 'Device information' by turning setting knob **"1"**.
- Press setting knob **"1"**; 'Device information' opens
- Turn setting knob **"1"** to display the desired appliances

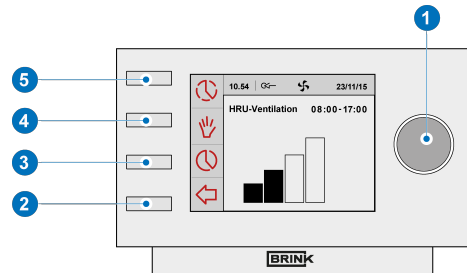

Take note!

You can look at, but not change, the settings via the info menu.

5.8 Factory setting connected device

A device has been connected to the Brink Air Control- Ventilation. It is possible to set back all this device's settings to the factory settings. Perform the following actions for this:

- Press returnkey **"2"** as many times as necessary to get to the main screen
- Press setting knob **"1"** 'Main Menu' opens
- Select 'Installation Settings' by turning setting knob **"1"**.
- Press setting knob **"1"**; 'Installation Settings' opens
- Select 'Installer' by turning setting knob **"1"**.
- Press setting knob **"1"**; 'Installer' opens
- Select 'Factory Setting' by turning setting knob **"1"**.
- Press setting knob **"1"**; 'Factory Setting' opens
- Turn setting knob **"1"** to select the option 'yes'
- Press setting knob **"1"** to confirm the desired 'Factory Setting' (or select the choice HRV appliance if only one appliance is connected).
- The settings are put back to the factory settings. Selecting factory setting will restore all step numbers to the original factory setting. All fault messages will be deleted as well.

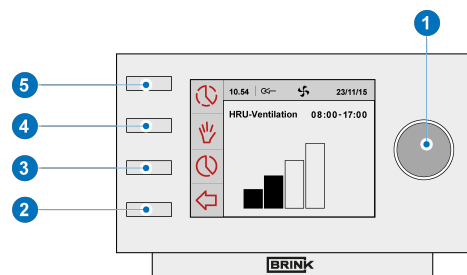

6 Maintenance

6.1 General maintenance



Careful!

Clean the Brink Air Control- Ventilation with a soft cloth.
Never apply water and/or (cleaning) liquid to the Brink Air Control- Ventilation.

6.2 Cleaning or replacing filter

6.2.1 Filter notification

The filters in the device, connected to the Brink Air Control- Ventilation, should be cleaned or replaced when the text 'FILTER' appears on the Brink Air Control- Ventilation display.

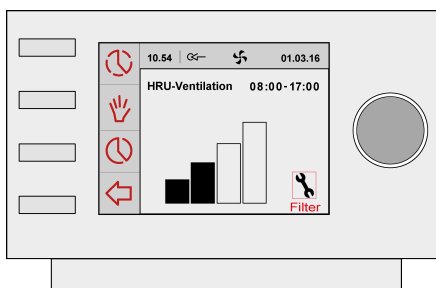

6.2.2 Removing, cleaning or replacing

Consult the manual of the device connected to the Brink Air Control- Ventilation for removing, cleaning and replacing filter(s).

6.2.3 Re-setting filter notification

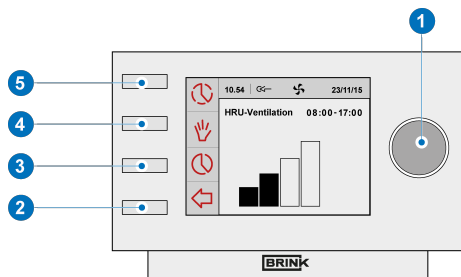

- You can reset the filter notification after you have cleaned or replaced the filter (or the filters). For this you press the setting knob "1" for at least five seconds .
- Press returnkey "2" to get to the main screen.
- The text filter on the Brink Air Control-Ventilation display disappears.

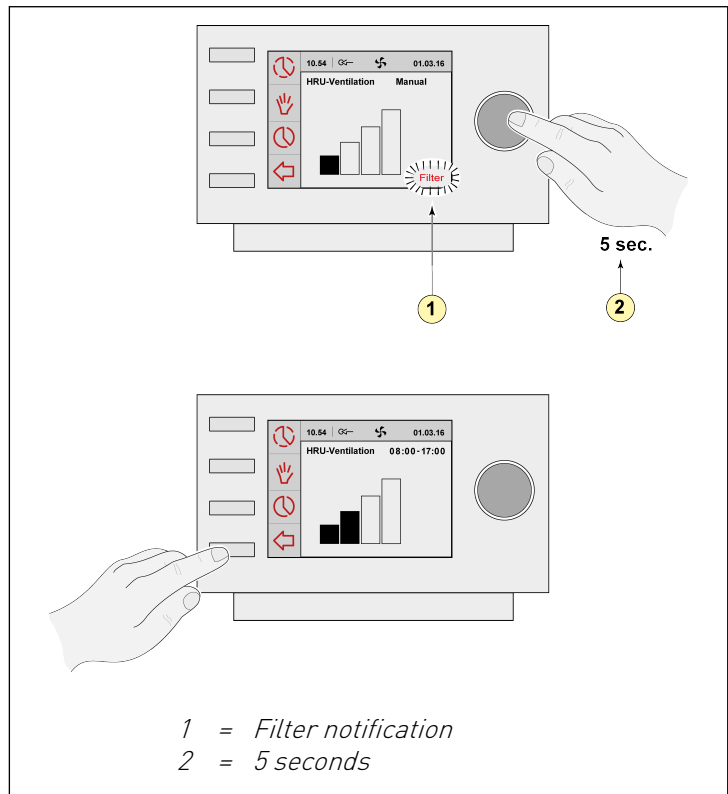

7 Dismanteling



Warning!

You are not permitted to dismantle the Brink Air Control- Ventilation or parts of the Brink Air Control- Ventilation by yourself. This may only be done by a maintenance mechanic approved by Brink Climate Systems B.V..

8 Repair



Warning!

You are not permitted to open or repair the Brink Air Control- Ventilation or parts of the Brink Air Control- Ventilation by yourself. This may only be done by a maintenance mechanic approved by Brink Climate Systems B.V.

9 Environment

Take note!



The Brink Air Control- Ventilation may not be removed as unsorted urban waste, but should be treated separately.

Make enquiries within your own region, where the Brink Air Control- Ventilation can be handed in when use has been terminated. Do not throw away electrical devices or parts, but check if (parts of) the Brink Air Control- Ventilation cannot be handed in, recycled or re-used.

RoHS-compliance

This product meets Directive 2011/65/EU of the European Parliament and the Council of 27 January 2003 regarding using certain environmentally hazardous substances in electronic equipment (RoHS) and the amendments to the directive.

WEEE-notification

The WEEE-directive (Waste Electrical and Electronic Equipment), which came into force, as European law, on 13 February 2003, has resulted in an important change in treating electronic equipment at the end of their use cycle. This directive's objective is, firstly, preventing electronic equipment in waste and moreover promoting re-use, recycling and other forms of recovering such waste in order to limit the amount of waste.

The WEEE-logo on a product or on the packaging indicates that this product may not be disposed of or thrown away with domestic waste. You should dispose of all your old electronic or electrical equipment via special collection points for such dangerous waste. Separate collection and correct treatment of our old electronic and electrical equipment help us to maintain our natural resources.

Moreover, correct recycling guarantees the safety and health of humankind and the environment. For more information on processing electronic and electrical equipment, re-use and collection points, please contact your municipality, your local waste disposal company, the supplier from whom you purchased the device or the device's manufacturer.

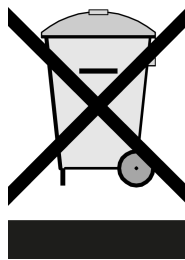

WEEE logo

Handing in and recycling

Make enquiries within your own region, where the Brink Air Control- Ventilation can be handed in when use has been terminated. Do not throw away electrical devices or parts, but check if (parts of) the Brink Air Control- Ventilation cannot be handed in, recycled or re-used.

10 Troubleshooting and guarantee

10.1 Troubleshooting

See the installation instructions of the device connected to the Brink Air Control- Ventilation for troubleshooting for the error notifications indicated on the Brink Air Control- Ventilation.

10.2 Guarantee

The Brink Air Control- Ventilation has been manufactured by Brink Climate Systems B.V. with care and in accordance with high quality standards. The Brink Air Control- Ventilation operation is guaranteed for a period of two years from the time of delivery. This guarantee is granted in accordance with Brink Climate Systems B.V. General Terms and Conditions.

These can be found on www.brinkclimatesystems.nl.

Do you want to claim under the guarantee?

You then have to make that known, in writing, via:

Brink Climate Systems B.V.

Mailbox 11

NL-7950 AA, Staphorst, The Netherlands

The right to guarantee lapses in case of incorrect or improper use of the Brink Air Control- Ventilation and failure to follow the user indications in this user's manual.



Warning!

Making changes to the Brink Air Control- Ventilation hardware or software is not permitted.





This can have an effect on the Brink Air Control- Ventilation proper operation and in that case all guarantees lapse.

You are not permitted to open or repair the Brink Air Control- Ventilation or parts of the Brink Air Control- Ventilation by yourself. In that case guarantees lapse.

11 Appendix: Standard settings weekly programs



11.1 Standard program P1

Week (Monday through Sunday)







Period	Start time	Ventilation mode
1	07.00	
2	08.00	
3	17.00	
4	22.00	
5	Not set	
6	Not set	

11.2 Standard program P2

Week (Monday through Friday)







Period	Start time	Ventilation mode
1	07.00	
2	08.00	
3	17.00	
4	22.00	
5	Not set	
6	Not set	

Weekend (Saturday and Sunday)

Period	Start time	Ventilation mode
1	08.00	
2	23.00	
3	Not set	
4	Not set	
5	Not set	
6	Not set	

11.3 Standard program P3

Monday

Period	Start time	Ventilation mode
1	07.00	
2	08.00	
3	17.00	
4	22.00	
5	Not set	
6	Not set	

Tuesday (the same as Monday)

Wednesday (the same as Monday)

Thursday (the same as Monday)

Friday (the same as Monday)

Saturday (the same as Monday)

Sunday (the same as Monday)



Brink Climate Systems B.V.

P.O. Box 11, NL-7950AA Staphorst

T: +31 (0) 522 46 99 44

E: info@brinkclimatesystems.nl

www.brinkclimatesystems.nl